

Hydraulic attachment tools

Demolition, waste management and earth-moving.



Levelling the working field

The straight design of the Demolition Pulverizer makes it optimally suited for primary demolition and secondary reduction of non-reinforced and reinforced concrete structures.

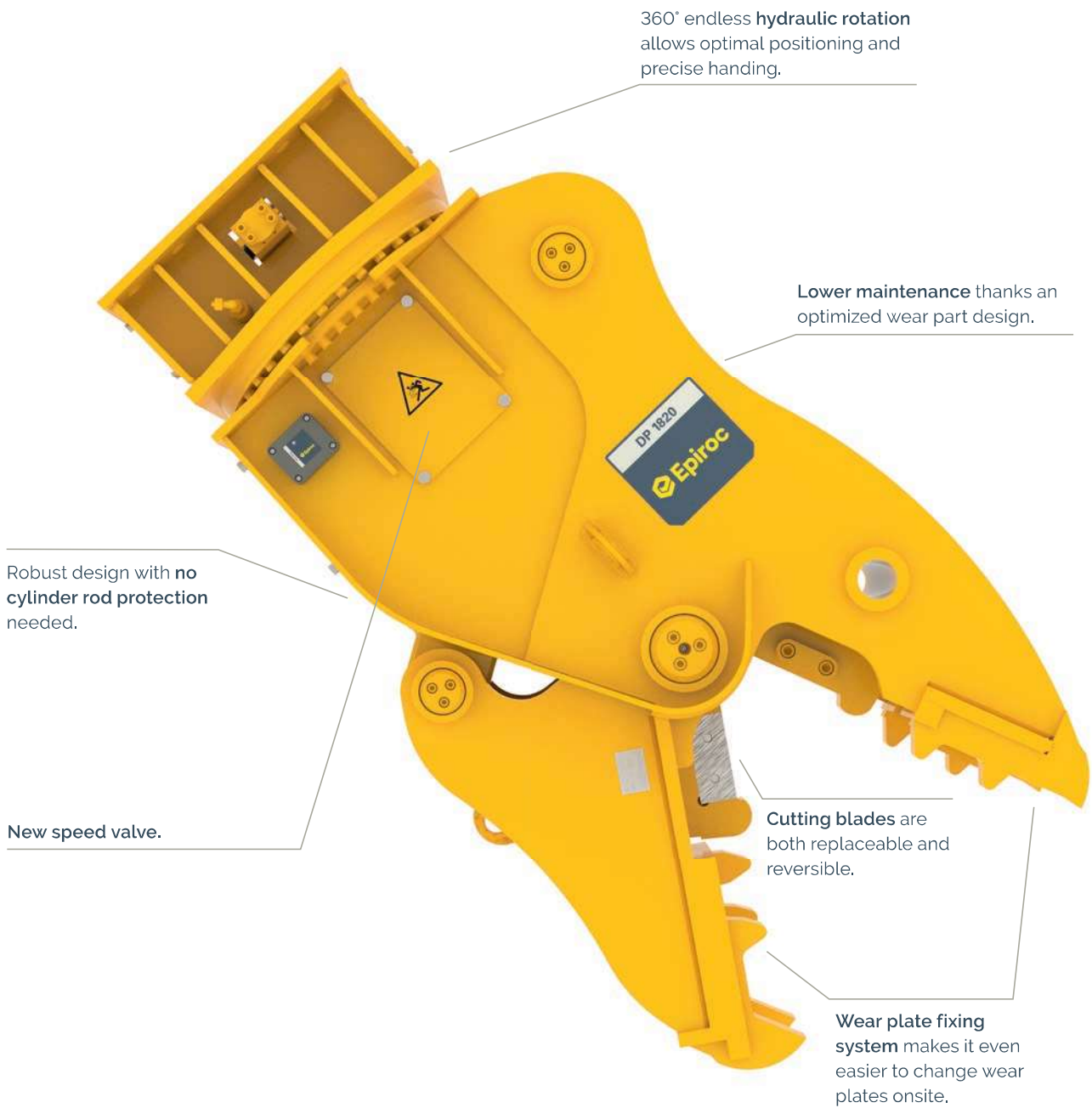

360° endless **hydraulic rotation** allows optimal positioning and precise handling.

Lower maintenance thanks an optimized wear part design.

Robust design with **no cylinder rod protection** needed.

New speed valve.

Cutting blades are both replaceable and reversible.

Wear plate fixing system makes it even easier to change wear plates onsite.



Long-term use is guaranteed by the extremely robust design of the Demolition Pulverizers. Wear parts are also easily replaced on-site.

DP range		DP 1820	DP 2000	DP 2800
Carrier weight class ¹	t	15–22	18–27	25–35
Service weight ²	kg	1.820	2.250	2.990
Product weight	kg	1.650	2.050	2.780
A	mm	2.155	2.320	2.550
B	mm	746	780	965
C	mm	720	650	930
D	mm	190	190	350
X	mm	260	340	345
Y	mm	400	460	480
F1	t	227	265	320
F2	t	71	85	100
Cycle time (opening/closing)	sec	1.8/1.6	1.9/2.0	2.2/1.9
Oil flow rate (opening & closing)	l/min	140–200	150–250	250–350
Max. operating pressure (opening & closing)	bar	350	350	350
Oil flow rate (rotation)	l/min	35–50	35–50	35–50
Max. operating pressure (rotation)	bar	170	170	170

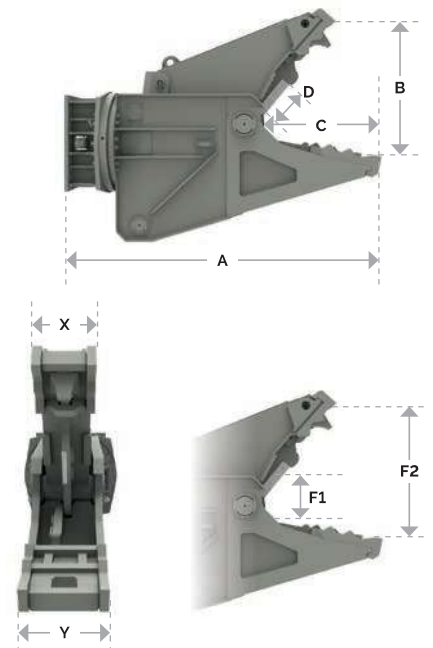

¹ Weights apply to standard carriers only. Any variances must be agreed with Epiroc and/or the carrier manufacturer prior to attachment.

² Attachment with average-sized adapter plate





Our consumables and wear parts are the right choice when maximum output and low lifecycle cost are in focus of your daily work.



You can find our consumables catalog for hydraulic breakers here.





You can find our consumables catalog for silent deconstruction tools and drum cutters here.

-  facebook.com/epirocdemolition
-  facebook.com/epirocgroup
-  twitter.com/epirocgroup
-  instagram.com/epirocgroup
-  linkedin.com/company/epiroc





Western Australia:

 +61 8 9248 9800
 +61 8 9209 3697



71 Prestige Parade,
Wangara, Perth
WA 6065

Queensland & NT:

 +61 7 3635 7333
 +61 7 3635 7355

76 Dulacca Street
Acacia Ridge, Brisbane
QLD 4110

Victoria:

 +61 3 9308 8202
 +61 3 9308 8872

32 Freight Drive
Somerton, Melbourne
VIC 3062

WWW.BAEG.COM.AU

sales@baeg.com.au

United in performance. Inspired by innovation.

Performance unites us, innovation inspires us, and commitment drives us to keep moving forward. Count on Epiroc to deliver the solutions you need to succeed today and the technology to lead tomorrow.

epiroc.com

